

IT8800 High Power DC Electronic Load



IT8800 series has wide power range 150W~10kW, voltage and current measurement speed up to 50kHz, resolution up to 0.1mV/0.01mA, adjustable measurement current rising speed 0.001A/us~2.5A/us, built-in RS232/GPIB/USB interface. IT8800 series has wide application fields because of its high performance, it has been applied to LED lighting, aerospace, automotive electronics and other fields.

Applications

High power testing, battery test, power supply test, aerospace testing

Feature

- 150W-10kW/120-800V/15-500A
- CV/CC/CR/CW mode
- Remote sense
- Measurement resolution:0.1mV,0.01mA
- Dynamic mode: up to 25 KHz
- Adjustable current rising slope: 0.001A/us~2.5A/us
- Measurement speed: up to 50KHz
- Dynamic test, short-circuit test function
- Rotary knob, making the operation more easier
- CR-LED test
- OCP / OVP / OPP / OTP/ Reverse polarity protection
- 100 groups memory capacity
- Power off memory function
- External analog control
- Support VISA/USBTMC/SCPI communication protocol
- Built-in RS232/USB/GPIB communication interface
- Software monitoring via PC

| Model | Voltage | Current | Power | Size |
|---------|---------|---------|-------|--------|
| IT8811 | 150W | 120V | 30A | 1/2 2U |
| IT8812 | 250W | 120V | 30A | 1/2 2U |
| IT8812B | 200W | 500V | 15A | 1/2 2U |
| IT8812C | 250W | 120V | 60A | 1/2 2U |
| IT8813 | 750W | 120V | 60A | 3U |
| IT8813B | 750W | 500V | 30A | 3U |
| IT8813C | 750W | 120V | 120A | 3U |
| IT8814 | 1500W | 120V | 120A | 3U |
| IT8814B | 1200W | 500V | 60A | 3U |
| IT8816 | 3KW | 120V | 240A | 3U |
| IT8816B | 2500W | 500V | 100A | 3U |
| IT8817 | 4500W | 120V | 360A | 6U |
| IT8817B | 3600W | 500V | 120A | 6U |
| IT8818 | 6KW | 120V | 480A | 6U |
| IT8818B | 5KW | 500V | 150A | 6U |
| IT8819H | 7.5KW | 800V | 80A | 12U |
| IT8830 | 10KW | 120V | 500A | 12U |
| IT8830B | 10KW | 500V | 200A | 12U |
| IT8830H | 10KW | 800V | 100A | 12U |

Dynamic mode up to 25KHz

Dynamic mode operation allows the electronic load to be switched between the two setting parameters according to the setting rules. Dynamic mode can be used to test the dynamic nature of the power supply, e.g. when the computer disk drive run or stop, the dynamic load mode can simulate the change of operating current.

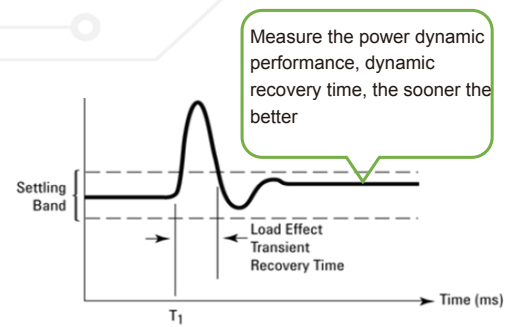

Voltage Rising/Falling time test

IT8800 provides unique measurement function to test voltage rising/falling time. Enter the measure menu under config, and set two voltage points. Then turn on display on timer function, and the rising / falling time is displayed on the screen after completing test.

This test is important for switching power supply testing and fuse testing.

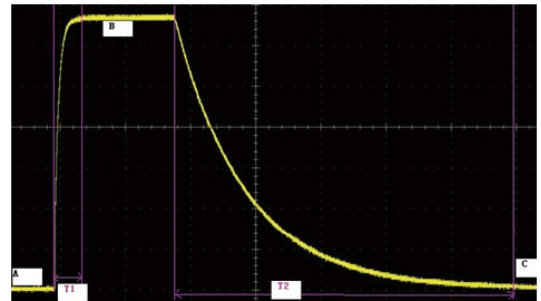

Adjustable Rising/Falling speed of current

List mode allows you to generate a complex current sequence. Moreover, the mode change can be synchronized with an internal or external signal, to accomplish dynamic and precise test. A list file includes following parameters: file name, step counts (range 2-84), time width of single step (0.00002s-3600s), step value and slope. The LIST function can make many kinds of complex sequences, to meet complicated test requirements.

IT8800 electronic load supports panel programming and computer software operation, especially for electronic product development, production line product aging, quality inspection and other complex application environment.

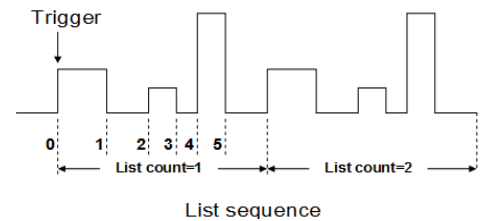

External analog test

IT8800 electronic load can control the loading voltage or current through the EXT PRG (positive and negative) analog port on the rear panel, connect 0-10V adjustable voltage to simulate 0- full-scale input in the EXT PRG terminal, so as to adjust the load input voltage and current value.

Analog control interface meets the control needs of industrial production, users can achieve output voltage control via PLC without the PC control.

Battery discharge testing in special aviation

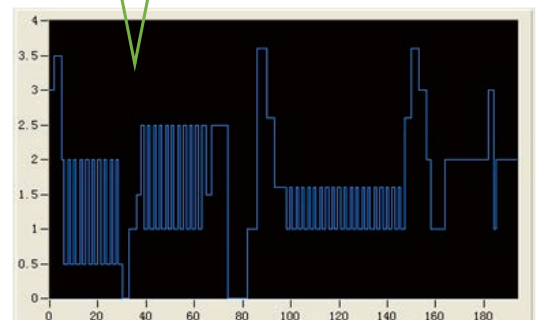

CR-LED test

As we all know the LED constant power supply output waveform usually have large current ripple. This is because the traditional type DC loads can't simulate the actual characteristic of LED driver, its testing current and voltage will shake. Based on traditional CR mode, CR-LED mode of IT8800 series adds the setting item of diode break-over voltage. Only when the input voltage is above the set value, the DC load will start to work. Thus, the IT8800 series can simulate the actual characteristic of LED.

IT8800 unique LED mode can provide LED power drive test, which can be used in LED power simulation.

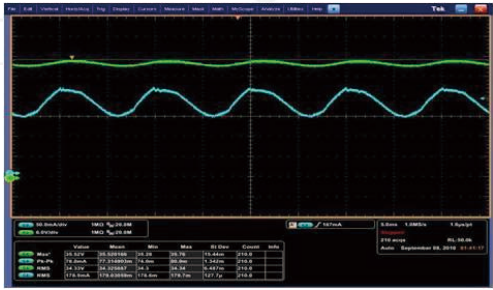

Current monitor

IT8800 series allows the users to monitor actual current through I-monitor terminal. Users could connect an oscilloscope to observe actual current. It will generate at 0-10V analog signal to represent to 0-100% rated current of the front panel.

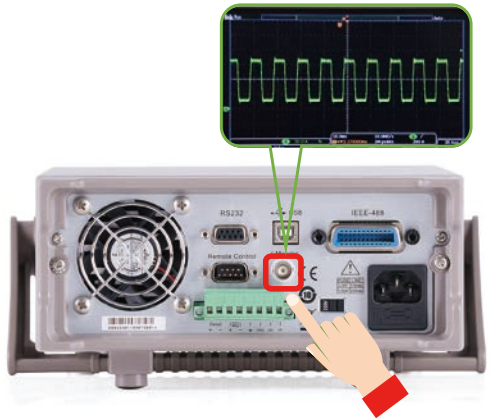

Battery discharge test function

IT8800 series electronic load can respectively set turn off voltage, cut-off capacity, discharge time through the panel and software to be as battery discharge cut-off conditions. The test is automatically stopped when the battery drops to the off voltage or has been discharged to the cut-off capacity or reaches the cut-off time. During the test, you can observe the battery voltage, discharge time and battery discharge capacity.

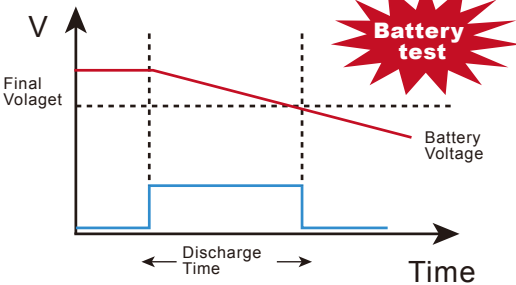

Working mode

The working mode of IT8800 series has CC, CV, CP, CR, and it will make you easy to simulate various characteristics of load, which can save cost greatly. It support OVP, OCP, OPP, OTP, reverse polarity protection and it can set the protection point of current, voltage, and power. In every condition, it will make auditory alarm and cut off the circuit to ensure the safety during test.

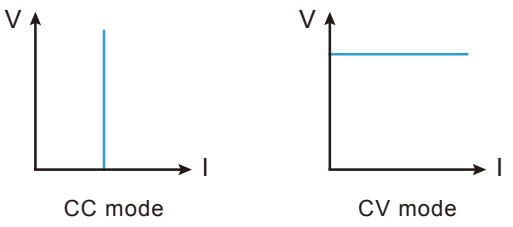

Auto test function

IT8800 auto test function can simulate many kinds of testing. It totally can edit 10 test files, and can make connection between one file and another. Also you can choose the condition to stop the test: stop when testing pass or fail. Its adjustable current speed rate of rising and falling can make auto test to simulate kinds of test waveform.

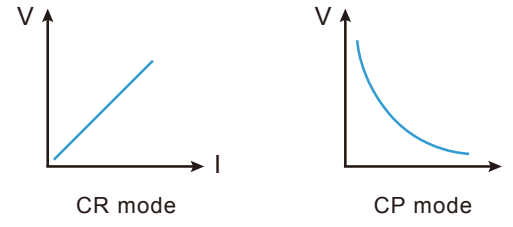

Supporting two loading modes

IT8800 series supports loading voltage setting, and it provides two kinds of load modes. Choosing Living means working goes after status, when choosing latch, it means work load point latch with loading states. It can meet different test requirements.

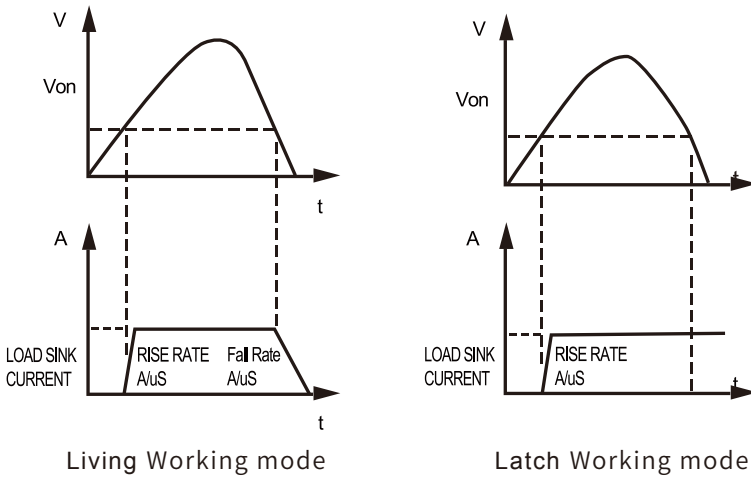

Remote sense function

In CC, CV, CR and CP mode, when load consume high current, it will cause large voltage-drop on the connection wires between tested instrument and terminals of load. Using remote sensing, you can sense the voltage at the power supply's terminals, effectively removing the effect of the voltage drop in the connection wires. In order to avoid the voltage-drop because of too long wires, remote test allows testing on the input terminals to improve the test accuracy.

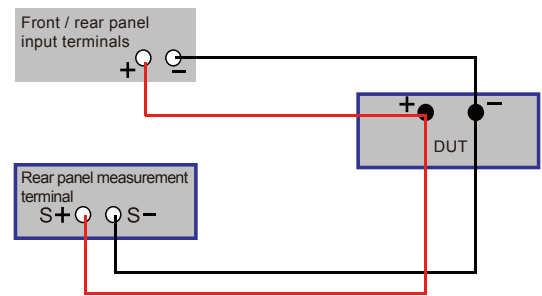

OCP/OPP test

OCP / OPP are mainly used in lithium battery protection board test, power module over current and over power point test. Through the built-in OCP and OPP function, users can test by built-in OCP program start current setting , cut-off current, step current, as well as the duration of each stage current, etc. IT8800 series can automatically capture the OCP point, with the automatic fast function, users can save a lot of verification time when using for design verification and production line system.

Panel operation

It is very convenient to operate the load panel, its shot-cut buttons are as follows: short circuit test, dynamic test, list test, data save, data recall, battery test, auto-test, test stop, test trigger, over current test, over power test.

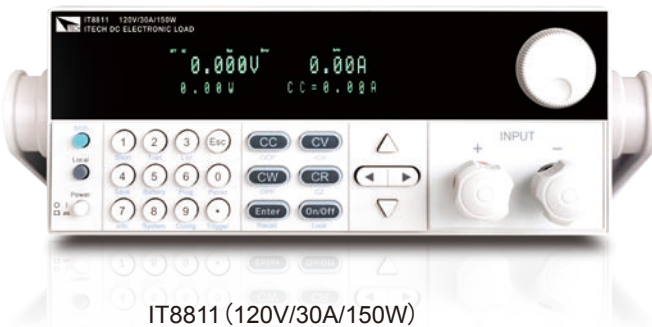

IT8811 (120V/30A/150W)

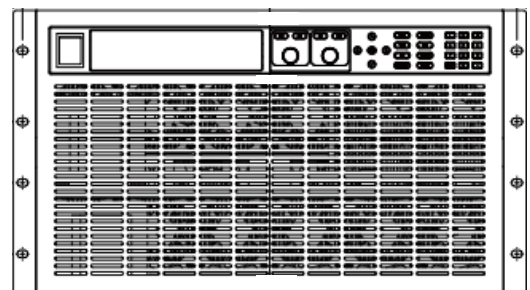

IT8818B (500V/150A/5000W)

IT8800 High Power DC Electronic Load

Electronic Load

| Field | DUT | Test items |
|-----------------------------|---|--|
| Automotive electronics | Radio, Car heating seats; Car doors and windows switch | Judge the working current |
| | Auto-car doors and windows switch | Stability and aging test |
| | Car central control box | Stability and aging test |
| Battery | Power Battery | Discharge test |
| | Cell phone battery | Discharge test |
| | Solar battery | Discharge, efficiency and other tests |
| | Mobile power | Discharge test |
| power supply | Power supply module, power supply | Performance testing |
| | Regulated power supply, constant current source, constant voltage source | Performance testing |
| | Switching power supply | Performance testing |
| | Charger | Performance testing |
| | Power supply for medical equipment | Energy storage test |
| | Power supply for military, aerospace equipment, scientific research equipment | Performance testing |
| | UPS | Energy storage test |
| LED | LED drive power supply | Electrical parameters and stability test |
| Power electronic components | MOSFET, IGBT | Performance testing |
| | Capacitors, rectifiers | Performance testing |
| | PFC module | Performance testing |
| Fuse | Fuse | Fuse time test |



IT8813B



IT8818-6U

IT8811/12 Specifications

| | | IT8811 | | IT8812 | | IT8812B | | IT8812C | |
|----------------------------|----------------------------|--|-----------------|-----------------------|-----------------|-----------------------|-----------------|---------------------|----------------|
| Rated (0~40 C) | Input voltage | 0~120V | | 0~120V | | 0~500V | | 0~120V | |
| | Input current | 0~3A | 0~30A | 0~3A | 0~30A | 0~3A | 0~15A | 0~6 A | 0~60A |
| | Input power | 150 W | | 250W | | 200W | | 250W | |
| | Min operating voltage | 0.11V at 3A | 1.1V at 30A | 0.11V at 3A | 1.1V at 30A | 0.9V at 3A | 4.5V at 15A | 0.18V at 6A | 1.8V at 60A |
| CV mode | Range | 0.1~18V | 0.1~120V | 0.1~18V | 0.1~120V | 0.1~50V | 0.1~500V | 0.1~18V | 0.1~120V |
| | Resolution | 1 mV | 10 mV | 1mV | 10mV | 1mV | 10mV | 1mV | 10mV |
| | Accuracy | ±(0.05%+0.025% FS) | | ±(0.05%+0.025%FS) | | ±(0.05%+0.025%FS) | | ±(0.05%+0.025%FS) | |
| CC mode | Range | 0~3A | 0~30A | 0~3A | 0~30A | 0~3A | 0~15A | 0~6A | 0~60A |
| | Resolution | 0.1mA | 1mA | 0.1mA | 1mA | 0.1mA | 1mA | 0.1mA | 1mA |
| | Accuracy | ± (0.05% + 0.05%FS) | | | | | | | |
| CR mode ^{*1} | Range | 0.05Ω~10Ω | 10Ω~7.5KΩ | 0.05Ω~10Ω | 10Ω~7.5KΩ | 0.3Ω~10Ω | 10 Ω~7.5KΩ | 0.05Ω~10Ω | 10Ω~7.5KΩ |
| | Resolution | 16 bit | | | | | | | |
| | Accuracy | 0.01% + 0.08s | 0.01% + 0.0008s | 0.01% + 0.08s | 0.01% + 0.0008s | 0.01% + 0.08s | 0.01% + 0.0008s | 0.01%+0.08s | 0.01%+0.0008s |
| CP mode ^{*2} | Range | 150W | | 250W | | 200W | | 250W | |
| | Resolution | | | 10mW | | | | | |
| | Accuracy | 0.1% + 0.1%FS | | 0.1% + 0.1%FS | | 0.1% + 0.1%FS | | 0.2% + 0.2%FS | |
| Dynamic mode ^{*3} | | Dynamic mode | | | | | | | |
| | T1&T2 | CC mode | | | | | | | |
| | Accuracy | 20 μs~3600s / Res:1 μs 5 μs±100 ppm | | | | | | | |
| | Rise / fall slope | 0.0001~0.25A/μs | 0.001~2.5 A/μs | 0.0001~0.25 A/μs | 0.001~2.5 A/μs | 0.0001~0.1 A/μs | 0.001~1 A/μs | 0.0001~0.25 A/μs | 0.001~2.5 A/μs |
| Readback Voltage | | Measuring range | | | | | | | |
| | Range | 0~18V | 0~120V | 0~18V | 0~120V | 0~50V | 0~500V | 0~18V | 0~120V |
| | Resolution | 0.1mV | 1mV | 0.1mV | 1 mV | 1mV | 10 mV | 0.1mV | 1mV |
| | Accuracy | ± (0.025% + 0.025%FS) | | | | | | | |
| Readback Current | Range | 0~3A | 0~30A | 0~3A | 0~30A | 0~3 A | 0~15A | 0~6A | 0~60A |
| | Resolution | 0.01mA | 0.1mA | 0.01mA | 0.1mA | 0.01mA | 0.1mA | 0.1mA | 1mA |
| | Accuracy | ± (0.05% + 0.05%FS) | | ± (0.05% + 0.05%FS) | | ± (0.05% + 0.05%FS) | | ± (0.05% + 0.1%FS) | |
| Readback Power | Range | 150W | | 250W | | 200W | | 250W | |
| | Resolution | | | 10mW | | | | | |
| | Accuracy | ± (0.1% + 0.1%FS) | | ± (0.1% + 0.1%FS) | | ± (0.1% + 0.1%FS) | | ± (0.2% + 0.2%FS) | |
| Over power protection | | Protected range | | | | | | | |
| | ≅ 160W | ≅ 260W | | ≅ 210W | | ≅ 260W | | | |
| | ≅ 3.3A | ≅ 33A | ≅ 3.3A | ≅ 33 A | ≅ 3.3A | ≅ 16.5A | ≅ 6.6A | ≅ 66 A | |
| | ≅ 130V | ≅ 130V | | ≅ 530V | | ≅ 130V | | | |
| Over voltage protection | ≅ 85°C | | | | | | | | |
| Short circuit | | Specifications | | | | | | | |
| | Current | ≅ 3.3/3A | ≅ 33/30A | ≅ 3.3/3A | ≅ 33/30A | ≅ 3.3/3A | ≅ 16.5/15A | ≅ 6.6 /6A | ≅ 66 A/60A |
| | Voltage | 0 V | | | | | | | |
| Resistance | ≅ 35mΩ | | ≅ 35mΩ | | ≅ 300mΩ | | ≅ 30 mΩ | | |
| Input terminal impedance | 300KΩ | | 300KΩ | | 1MΩ | | 300 KΩ | | |
| Size(W*H*D) | 214.5 mm* 88.2 mm* 354.6mm | | | | | | | | |

*1 Voltage/current input value is not less than 10% FS (FS for full scale)

*2 Voltage/current input values is not less than 10% FS

*3 Up/down slope: 10% ~ 90% current rising slope when from 0 to the maximum current

* This information is subject to change without notice

IT8811/12 Dimension figure

1/2 2U, 150 W~300 W

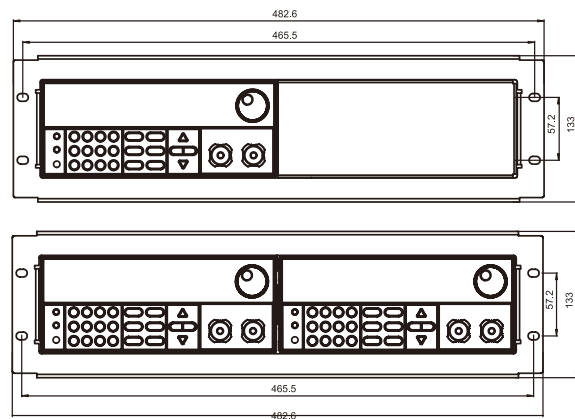
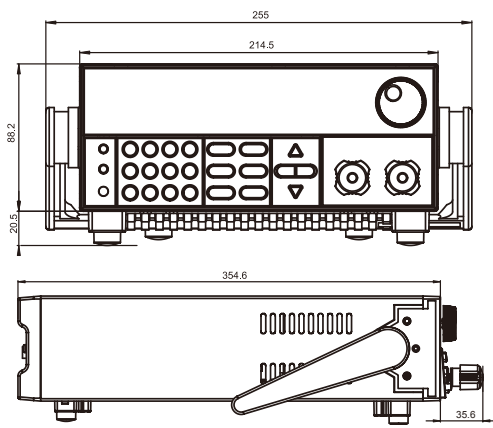

Unit: mm

IT8813/14 Specifications

| | IT8813 | IT8813B | IT8813C | IT8814 | IT8814B |
|-----------------------------|--------------------------|---------------------------|----------------------------|-----------------------------|---|
| Rated (0~40°C) | Input voltage | 0~120V | 0~500V | 0~120V | 0~500V |
| | Input current | 0~6A 0~60A | 0~3A 0~30A | 0~12A 0~120A | 0~12A 0~120A 0~6A 0~60A |
| | Input power | 750W | 750W | 750W | 1500W 1200W |
| | Min operating voltage | 0.1Vat6A 1.0Vat60A | 0.36Vat3A 3.6V at 30A | 0.12V/12A 1.2V/120A | 0.12Vat12A 1.2Vat120A |
| CV mode | Range | 0.1~18V 0.1~120V | 0.1~50V 0.1~500V | 0.1~18V 0.1~120V | 0.1~18V 0.1~120V 0.1~50V 0.1~500V |
| | Resolution | 1mV 10mV | 1mV 10mV | 1mV 10mV | 1mV 10mV 1mV 10mV |
| | Accuracy | ±(0.025%+0.05% FS) | | ±(0.025%+0.05%FS) | ±(0.025%+0.05%FS) |
| CC mode | Range | 0~6A 0~60A | 0~3A 0~30A | 0~12A 0~120A | 0~12A 0~120A 0~6A 0~60A |
| | Resolution | 0.1mA 1mA | 0.1mA 1mA | 1mA 10mA | 1mA 10mA 0.1mA 1mA |
| | Accuracy | ± (0.05% + 0.05%FS) | | ±(0.05%+0.1%FS) | ±(0.05%+0.05%FS) |
| CR mode ^{*1} | Range | 0.02Ω~10Ω 10Ω~7.5kΩ | 0.15Ω~10Ω 10Ω~7.5 KΩ | 0.02Ω~10Ω 10Ω~7.5KΩ | 0.01Ω~10Ω 10 Ω~7.5 kΩ 0.1 Ω~10 Ω 10Ω~7.5kΩ |
| | Resolution | 16 bit | | | |
| | Accuracy | 0.01%+0.08s 0.01%+0.0008s | 0.01%+0.08s 0.01%+0.0008s | 0.01%+0.08s 0.01%+0.0008s | 0.01%+0.08s 0.01%+0.0008s 0.01%+0.08s 0.01%+0.0008s |
| CP mode ^{*2} | Range | 750W | 750W | 750W | 1500W 1200W |
| | Resolution | 10mW | 10mW | 10mW | 100mW 100mW |
| | Accuracy | 0.2% + 0.2% FS | | 0.2% + 0.2% FS | 0.2% + 0.2% FS 0.2% + 0.2% FS |
| Dynamic mode ^{*3} | Dynamic mode | | | | |
| | CC mode | | | | |
| | T1&T2 | 20μs~3600s / Res:1 μs | | | |
| | Accuracy | 5μs±100 ppm | | | |
| Rise / fall slope | 0.0001~0.25A/μs | 0.001~2.5A/μs | 0.0001~0.1A/μs 0.001~1A/μs | 0.001~0.25A/μs 0.01~2.5A/μs | 0.001~0.1A/μs 0.001~1A/μs |
| Readback Voltage | Measuring range | | | | |
| | Range | 0~18V 0~120V | 0~50V 0~500V | 0~18V 0~120V | 0~18V 0~120V 0~50V 0~500V |
| | Resolution | 1mV 10mV | 1mV 10mV | 1mV 10mV | 1mV 10mV 1mV 10mV |
| | Accuracy | ± (0.025% + 0.025%FS) | | | |
| Readback Current | Range | 0~6A 0~60A | 0~3A 0~30A | 0~12A 0~120A | 0~12A 0~120A 0~6A 0~60A |
| | Resolution | 0.1mA 1mA | 0.1mA 1mA | 1mA 10mA | 1mA 10mA 0.1mA 1mA |
| | Accuracy | ± (0.05% + 0.05%FS) | | ±(0.05%+0.1%FS) | ± (0.05% + 0.05%FS) ± (0.05% + 0.05%FS) |
| Readback Power | Range | 750W | 750W | 750W | 1500W 1200W |
| | Resolution | 10mW | 10mW | 10mW | 100mW 100mW |
| | Accuracy | ± (0.2% + 0.2%FS) | | ± (0.2% + 0.2%FS) | ± (0.2% + 0.2%FS) ± (0.2% + 0.2%FS) |
| Protected range | | | | | |
| Over power protection | ≅ 760W | | ≅ 760W | ≅ 760W | ≅ 1550W ≅ 1250W |
| Over current protection | ≅ 6.6A ≅ 66A | ≅ 3.3A ≅ 33A | ≅ 13.2A ≅ 132A | ≅ 13.2 / 12A ≅ 132 / 120A | ≅ 6.6 A ≅ 66 A |
| Over voltage protection | ≅ 130V | | ≅ 530V | ≅ 130V | ≅ 130 V ≅ 530 V |
| Over temperature protection | ≅ 85°C | | | | |
| Specifications | | | | | |
| Short circuit | Current | ≅ 6.6/6A ≅ 66/60A | ≅ 3.3/3A | ≅ 13.2/12A 132/120A | ≅ 13.2/12A ≅ 132/120A ≅ 6.6/16A ≅ 66/160A |
| | Voltage | 0 V | | | |
| | Resistance | ≅ 15mΩ | | ≅ 120mΩ | ≅ 10mΩ ≅ 10 mΩ ≅ 60 mΩ |
| Input terminal impedance | 300KΩ | | 1 MΩ | 300KΩ | 300 KΩ 1 MΩ |
| Size(W*H*D) | 439 mm* 133.3 mm* 580 mm | | | | |

*1 Voltage/current input value is not less than 10% FS (FS for full scale)

*2 Voltage/current input values is not less than 10% FS

*3 Up/down slope: 10% ~ 90% current rising slope when from 0 to the maximum current

* This information is subject to change without notice

IT8813/14/16 Dimension figure (3U, 750 W~3000W)

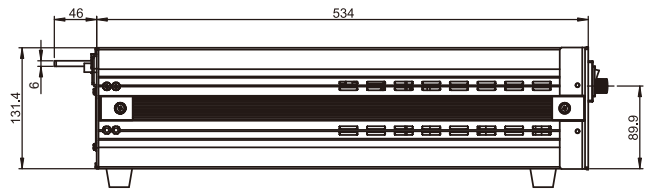
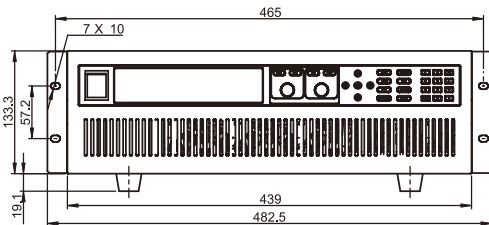

Unit: mm

IT8816/17 Specifications

| | IT8816 | | IT8816B | | IT8817 | | IT8817B | | |
|-----------------------------|--------------------------|-------------------------|---------------|-----------------------|------------------------|-----------------------|----------------|-----------------------|--------------|
| Rated (0~40°C) | Input voltage | 0~120 V | 0~500 V | 0~120 V | 0~500 V | 0~120 V | 0~500 V | 0~120 A | |
| | Input current | 0~24 A | 0~240 A | 0~10 A | 0~100 A | 0~36 A | 0~360 A | 0~12 A | |
| | Input power | 3000 W | 2.5 KW | 4500 W | 3.6 KW | 3000 W | 2.5 KW | 4500 W | |
| | Min operating voltage | 0.12Vat24A | 1.2Vat 240A | 0.3 V at 10 A | 3 V at 100 A | 0.15 V at 36A | 1.5 V at 360 A | 0.3 V at 12A | 3 V at 120 A |
| CV mode | Range | 0.1~18 V | 0.1~120 V | 0.1~50 V | 0.1~500 V | 0.1~18 V | 0.1~120 V | 0.1~50 V | |
| | Resolution | 1 mV | 10 mV | 1 mV | 10 mV | 1 mV | 10 mV | 1 mV | |
| | Accuracy | ±(0.025%+0.05% FS) | | ±(0.025%+0.05%FS) | | ±(0.025%+0.05%FS) | | ±(0.025%+0.05%FS) | |
| CC mode | Range | 0~24 A | 0~240 A | 0~10 A | 0~100 A | 0~36 A | 0~360 A | 0~12 A | |
| | Resolution | 1 mA | 10 mA | 1 mA | 10 mA | 1 mA | 10 mA | 1 mA | |
| | Accuracy | ± (0.05% + 0.05%FS) | | ± (0.05% + 0.05%FS) | | ± (0.05% + 0.1%FS) | | ± (0.05%+0.05%FS) | |
| CR mode ^{*1} | Range | 0.01 Ω~10 Ω | 10 Ω~7.5 KΩ | 0.03 Ω~10 Ω | 10 Ω~7.5 KΩ | 0.01Ω~10Ω | 10Ω~7.5KΩ | 0.03Ω~10Ω | |
| | Resolution | | | 16 bit | | | | | |
| | Accuracy | 0.01%+0.08S | 0.01%+0.0008S | 0.01%+0.08S | 0.01%+0.0008S | 0.01%+0.08S | 0.01%+0.0008S | 0.01%+0.08S | |
| CP mode ^{*2} | Range | 3000 W | 2.5 kW | 4500W | 3.6kW | 3000 W | 2.5 kW | 4500W | |
| | Resolution | | | 100 mW | | | | | |
| | Accuracy | | | 0.2% + 0.2% FS | | | | | |
| Dynamic mode ^{*3} | Dynamic mode | | | | | | | | |
| | CC mode | | | | | | | | |
| | T1&T2 | 20 μS~3600 S / Res:1 μS | | | | | | | |
| | Accuracy | 5 μS±100 ppm | | | | | | | |
| Rise / fall slope | 0.001~0.25A/μS | 0.01~2.5A/μS | 0.001~0.1A/μS | 0.01~1A/μS | 0.001~0.25A/μS | 0.01~2.5A/μS | 0.001~0.1A/μS | 0.01~1A/μS | |
| Readback Voltage | Measuring range | | | | | | | | |
| | Range | 0~18 V | 0~120 V | 0~50 V | 0~500 V | 0~18 V | 0~120 V | 0~50 V | |
| | Resolution | 1 mV | 10 mV | 1 mV | 10 mV | 1 mV | 10 mV | 1 mV | |
| Readback Current | Range | 0~24 A | 0~240 A | 0~10 A | 0~100 A | 0~36 A | 0~360 A | 0~12 A | |
| | Resolution | 1 mA | 10 mA | 1 mA | 10 mA | 1 mA | 10 mA | 1 mA | |
| | Accuracy | ± (0.05% + 0.05%FS) | | ± (0.05% + 0.05%FS) | | ± (0.05% + 0.05%FS) | | ± (0.05% + 0.05%FS) | |
| Readback Power | Range | 3000 W | 2.5 KW | 4500 W | 3.6 kW | 3000 W | 2.5 kW | 4500 W | |
| | Resolution | | | 100 mW | | | | | |
| | Accuracy | | | ± (0.2% + 0.2%FS) | | | | | |
| Over power protection | Protected range | | | | | | | | |
| | ≅ 3050 W | ≅ 2550 W | ≅ 4550 W | ≅ 3650 W | ≅ 3050 W | ≅ 2550 W | ≅ 4550 W | ≅ 3650 W | |
| | ≅ 26.4 A | ≅ 264 A | ≅ 11 A | ≅ 110 A | ≅ 39.6 A | ≅ 396 A | ≅ 13.2 A | ≅ 132 A | |
| | ≅ 130 V | ≅ 530 V | ≅ 130 V | ≅ 530 V | ≅ 130 V | ≅ 530 V | ≅ 130 V | ≅ 530 V | |
| Over temperature protection | ≅ 85°C | | | | | | | | |
| Short circuit | Specifications | | | | | | | | |
| | Current | ≅ 26.4/24 A | ≅ 264/240A | ≅ 11/10 A | ≅ 110/100 A | ≅ 39.6 /36A | ≅ 396/360 A | ≅ 13.2 /12A | ≅ 132/120 A |
| | Voltage | 0 V | | | | | | | |
| Resistance | ≅ 5 mΩ | | ≅ 30 mΩ | | ≅ 4 mΩ | | ≅ 25 mΩ | | |
| Input terminal impedance | 300kΩ | | 1 MΩ | | 300 kΩ | | 1 MΩ | | |
| Size(W*H*D) | 439 mm* 133.3 mm* 580 mm | | | | 439 mm* 266 mm* 590 mm | | | | |

*1 Voltage/current input value is not less than 10% FS (FS for full scale)

*2 Voltage/current input values is not less than 10% FS

*3 Up/down slope: 10% ~ 90% current rising slope when from 0 to the maximum current

* This information is subject to change without notice

IT8817 Dimension figure (6U, 3.6 kW~4.5kW)

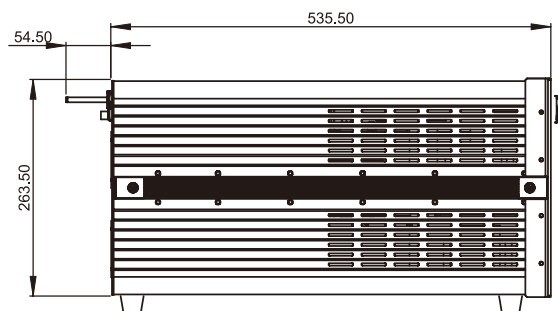
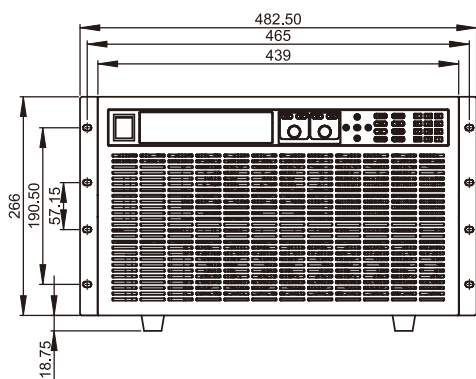

Unit: mm

IT8818 Specifications

| | | IT8818 | | IT8818B | |
|-----------------------------|------------------------|-------------------------|-------------------|-----------------------|-------------------|
| Rated (0~40 C) | Input voltage | 0~120 V | | 0~500 V | |
| | Input current | 0~48 A | 0~480 A | 0~15 A | 0~150 A |
| | Input power | 6 kW | | 5 kW | |
| | Min operating voltage | 0.15 V at 48 A | 1.5 V at 480 A | 0.3 V at 15 A | 3 V at 150 A |
| CV mode | Range | 0.1~18 V | 0.1~120 V | 0.1~50 V | 0.1~500 V |
| | Resolution | 1 mV | 10 mV | 1 mV | 10 mV |
| | Accuracy | ±(0.025%+0.05% FS) | ±(0.025%+0.05%FS) | ±(0.025%+0.05%FS) | ±(0.025%+0.05%FS) |
| CC mode | Range | 0~48 A | 0~480 A | 0~15 A | 0~150 A |
| | Resolution | 1 mA | 10 mA | 1 mA | 10 mA |
| | Accuracy | ± (0.05% + 0.1%FS) | | ± (0.05% + 0.05%FS) | |
| CR mode ^{*1} | Range | 0.005 Ω~10 Ω | 10 Ω~7.5 KΩ | 0.03 Ω~10 Ω | 10 Ω~7.5 KΩ |
| | Resolution | | 16 bit | | |
| | Accuracy | 0.01% + 0.08S | 0.01% + 0.0008S | 0.01% + 0.08S | 0.01%+0.0008S |
| CP mode ^{*2} | Range | 6 kW | | 5 kW | |
| | Resolution | 100 mW | | 100 mW | |
| | Accuracy | 0.2% + 0.2% FS | | 0.2% + 0.2% FS | |
| Dynamic mode | | | | | |
| Dynamic mode ^{*3} | T1&T2 | CC mode | | | |
| | Accuracy | 20 μS~3600 S / Res:1 μS | | | |
| | Rise / fall slope | 0.001~0.25A/μS | 0.01~2.5 A/μS | 0.001~0.1 A/μS | 0.01~1 A/μS |
| Measuring range | | | | | |
| Readback Voltage | Range | 0~18 V | 0~120 V | 0~50 V | 0~500 V |
| | Resolution | 1 mV | 10 mV | 1 mV | 10 mV |
| | Accuracy | ± (0.025% + 0.025%FS) | | | |
| Readback Current | Range | 0~48 A | 0~480 A | 0~15 A | 0~150 A |
| | Resolution | 1 mA | 10 mA | 1 mA | 10 mA |
| | Accuracy | ± (0.05% + 0.05%FS) | | | |
| Readback Power | Range | 6 kW | | 5 kW | |
| | Resolution | 100 mW | | 100 mW | |
| | Accuracy | ± (0.2% + 0.2%FS) | | | |
| Protected range | | | | | |
| Over power protection | ≅ 6050 W | | | ≅ 5050 W | |
| Over current protection | ≅ 52.8 A | | ≅ 528 A | ≅ 16.5A | ≅ 165 A |
| Over voltage protection | ≅ 130 V | | | ≅ 530 V | |
| Over temperature protection | ≅ 85°C | | | | |
| Specifications | | | | | |
| Short circuit | Current | ≅ 52.8/48 A | ≅ 528/480 A | ≅ 16.5/15 A | ≅ 165/150A |
| | Voltage | 0 V | | | |
| | Resistance | ≅ 3 mΩ | ≅ 3 mΩ | ≅ 20 mΩ | ≅ 20 mΩ |
| Input terminal impedance | | | 300 kΩ | | 1mΩ |
| Size(W*H*D) | 439 mm* 266 mm* 590 mm | | | | |

*1 Voltage/current input value is not less than 10% FS (FS for full scale)

*2 Voltage/current input values is not less than 10% FS

*3 Up/down slope: 10% ~ 90% current rising slope when from 0 to the maximum current

* This information is subject to change without notice

IT8818 Dimension figure (6U, 5kW~6kW)

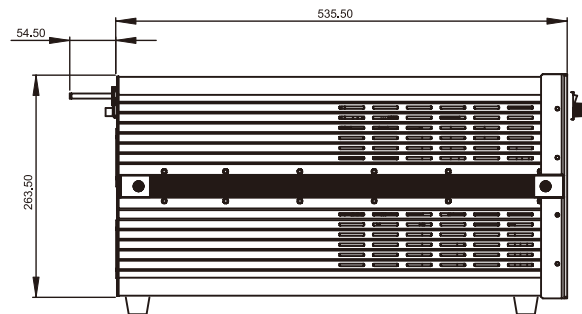
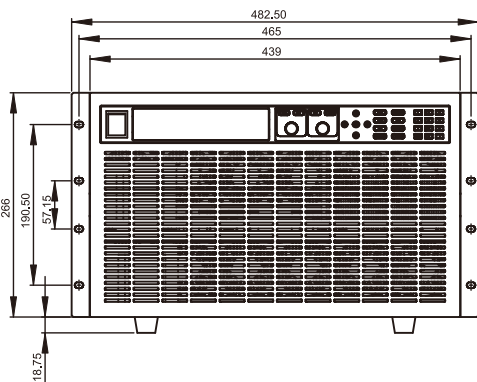

Unit: mm

IT8819/IT8830 Specifications

| | | IT8819H | | IT8830 | | IT8830H | |
|-----------------------------|-----------------------|--------------------|---------------|-------------------------|---------------|--------------------|---------------|
| Rated (0~40 C) | Input voltage | 0~800V | | 0~120 V | | 0~800V | |
| | Input current | 0~8A | 0~80A | 0~50A | 0~500A | 0~10A | 0~100A |
| | Input power | 7500W | | 10KW | | 10KW | |
| | Min operating voltage | 0.28V/8A | 2.8V/80A | 0.1V/50A | 1V/500A | 0.3V/10A | 3V/100A |
| CV mode | Range | 0.1~80V | 0.1~800V | 0.1~18V | 0.1~120 V | 0.1~80V | 0.1~800V |
| | Resolution | 1 mV | 10 mV | 1 mV | 10 mV | 1 mV | 10 mV |
| | Accuracy | ±(0.05%+0.05%FS) | | ±(0.025%+0.05% FS) | | ±(0.05%+0.05%FS) | |
| CC mode | Range | 0~8A | 0~80A | 0~50A | 0~500A | 0~10A | 0~100A |
| | Resolution | 1 mA | 10 mA | 1 mA | 10 mA | 1 mA | 10 mA |
| | Accuracy | ±(0.05%+0.05%FS) | | ±(0.05%+0.1%FS) | | ±(0.05%+0.05%FS) | |
| CR mode ^{*1} | Range | 0.05Ω~10Ω | 10Ω~7.5KΩ | 0.005Ω~10Ω | 10Ω~7.5KΩ | 0.05Ω~10Ω | 10Ω~7.5KΩ |
| | Resolution | 16 bit | | 16 bit | | 16 bit | |
| | Accuracy | 0.01%+0.08S | 0.01%+0.0008S | 0.01%+0.08S | 0.01%+0.0008S | 0.01%+0.08S | 0.01%+0.0008S |
| CP mode ^{*2} | Range | 7500W | | 10KW | | 10KW | |
| | Resolution | 1W | | 1W | | 1W | |
| | Accuracy | 0.2%+0.25%FS | | 0.2%+0.2%FS | | 0.2%+0.2%FS | |
| Measuring range | | | | | | | |
| Readback Voltage | Range | 0~80V | 0~800V | 0~18 V | 0~120 V | 0~80V | 0~800V |
| | Resolution | 1 mV | 10 mV | 1 mV | 10 mV | 1 mV | 10 mV |
| | Accuracy | ±(0.025%+0.025%FS) | | ± (0.025% + 0.025%FS) | | ±(0.025%+0.025%FS) | |
| Readback Current | Range | 0~8A | 0~80A | 0~50A | 0~500A | 0~10A | 0~100A |
| | Resolution | 1 mA | 10 mA | 1 mA | 10 mA | 1 mA | 10 mA |
| | Accuracy | ±(0.05%+0.05%FS) | | ± (0.05% + 0.05%FS) | | ±(0.05%+0.05%FS) | |
| Readback Power | Range | 7500W | | 10kW | | 10kW | |
| | Resolution | 1W | | 1W | | 1W | |
| | Accuracy | ±(0.2%+0.25%FS) | | ± (0.2% + 0.2%FS) | | ±(0.2%+0.2%FS) | |
| Protected range | | | | | | | |
| Over power protection | ≅ 7550W | | ≅ 10.1KW | | ≅ 10.1KW | | |
| Over current protection | ≅ 8.8A | ≅ 88A | ≅ 55A | ≅ 550A | ≅ 11A | ≅ 110A | |
| Over voltage protection | ≅ 850V | | ≅ 130V | | ≅ 850V | | |
| Over temperature protection | ≅ 85°C | | ≅ 85°C | | ≅ 85°C | | |
| Specifications | | | | | | | |
| Short circuit | Current | ≅ 8.8/8A | ≅ 88/80A | ≅ 55/50A | ≅ 550/500A | ≅ 11/10A | ≅ 110/100A |
| | Voltage | 0V | | 0V | | 0V | |
| Input terminal impedance | ≅ 35mΩ | | ≅ 2mΩ | | ≅ 30mΩ | | |
| Size(W*H*D) | 12U | | 12U | | 12U | | |

*1 Voltage/current input value is not less than 10% FS (FS for full scale)

*2 Voltage/current input values is not less than 10% FS

* This information is subject to change without notice

IT8819H Dimension figure

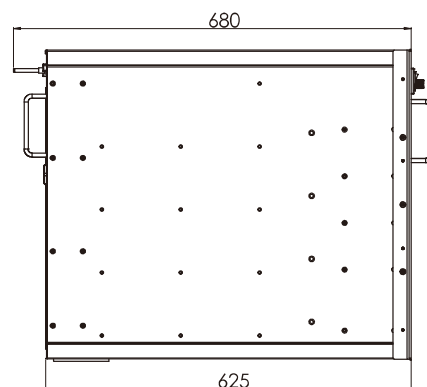
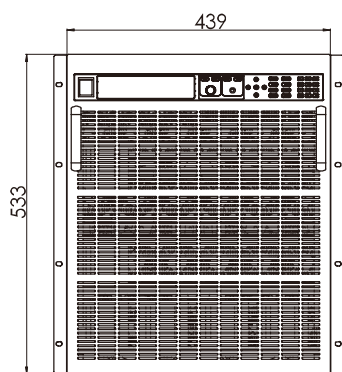

Unit: mm